



Crafting worlds of wonder...one map at a time.

Catalog Contents

- Overview
- Product Pages
- Bundles
- Categories
- Series & Settings
- Copyright

Overview



Royal
Scribe
Imaginarium

RSI on DTRPG

Storefront: [Royal Scribe Imaginarium](#)

Copyright: Kevin Goebel, publishing as
Royal Scribe Imaginarium

Products: 26 maps
2 map bundles

Date Launched: August 26, 2025

Last Updated: June 24, 2026



Royal
Scribe
Imaginarium

Map Pack Contents

The contents of each map pack are outlined in their descriptions on DriveThruRPG. Most RSI Map Packs include:

VTT PNG Files

- 70 px gridded and ungridded for faster loading
- 140 px or 150 px gridded and ungridded for richer details

Print PDF Tiles

- 8x8-inch printable tiles scaled: 1 inch = 5 map feet
- 300 dpi gridded and sometimes ungridded
- PDFs in US Letter and A4 formats

Map Guide PDF

- Descriptions of each area
- May include lore, historical notes, adventure hooks, suggested encounters, homebrewed options, and more



Product Pages



Royal
Scribe
Imaginarium

Product Title List

- [Aspidochelone](#)
- [Bramblewick](#)
- [Bramblewick Floorplans](#)
- [Coastal Fortress](#)
- [Deserted Island](#)
- [Drowned Sisters' Grotto](#)
- [Druid Henge](#)
- [Forest Temple Ruins](#)
- [Frostmaidens' Cradle](#)
- [Greco-Roman Temple & Crypts](#)
- [Grotto of the Goddess of Love](#)
- [Icy Ruins](#)
- [Lighthouse Battlemap](#)
- [Mapleford Church](#)
- [Mapleford Market Square](#)
- [Mapleford Village and Candle & Kettle Inn \(Holiday Map Pack\)](#)
- [Mapleford Village and Candle & Kettle Inn \(Summer Map Pack\)](#)
- [Mapleford Village and Candle & Kettle Inn \(Winter Map Pack\)](#)
- [Miremothers' Den](#)
- [The Old San Francisco Mint](#)
- [Rise of the Crone-Mother Campaign](#)
- [Royal Chapel](#)
- [Winter Wilderness](#)
- [Withering Glade](#)
- [Wizard's Tower](#)
- [Womb of Ashes](#)

Aspidochelone

The Island That Breathes

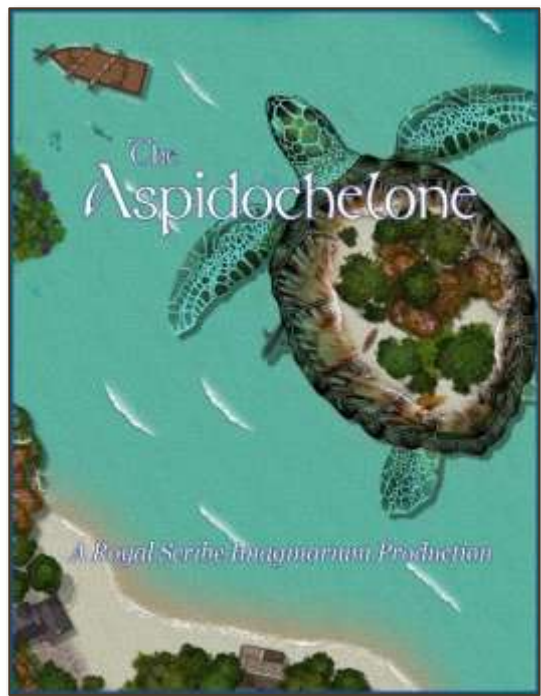

Price: \$1.99

Map Size: 240 x 240 feet

Size of Files: 497.59 MB

Published: Nov. 18, 2025

[DTRPG #546503](#)

For generations, sailors have whispered tales of an island that breathes. Sand warms beneath the sun, trees take root, and birds gather along the shoreline...until the “island” begins to shift.

Based on the legendary Aspidochelone – the colossal sea turtle mistaken for an island – this map pack brings one of the oldest maritime myths to life. Perfect as a dramatic encounter, a mysterious waystation, or a full adventure site, this living isle can drift into any seafaring campaign. Whether your players approach it cautiously or pitch camp upon its back, the ocean has a way of reminding travelers that the world is far older, and far stranger, than they imagined.

- **Maps Included:** 4 variants
- **Variants:** Hidden, Hidden with Hint, Visible, Submerged
- **Series:** Standalone Product
- **Categories:** Coastal Adventures
- **Adventure Use:** Travel Encounters
- **Keywords:** Sea Turtle, Sea Monster, Living Island, Maritime, Mythology



Aspidochelone Samples



GM's Version



Player Version



Player Version with a Hint



Underwater



What dangers lie beneath the waves?

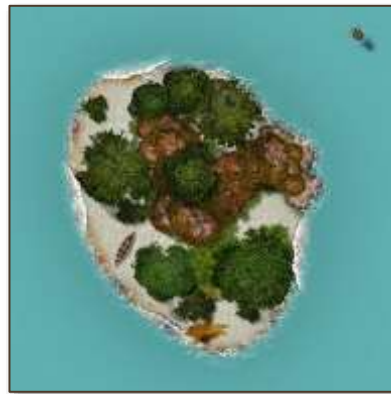

It's just a small island...that floats?



Please roll for Perception



Disturb the creature at your peril!

Bramblewick

A Hidden Gnome Haven in Wonderwood

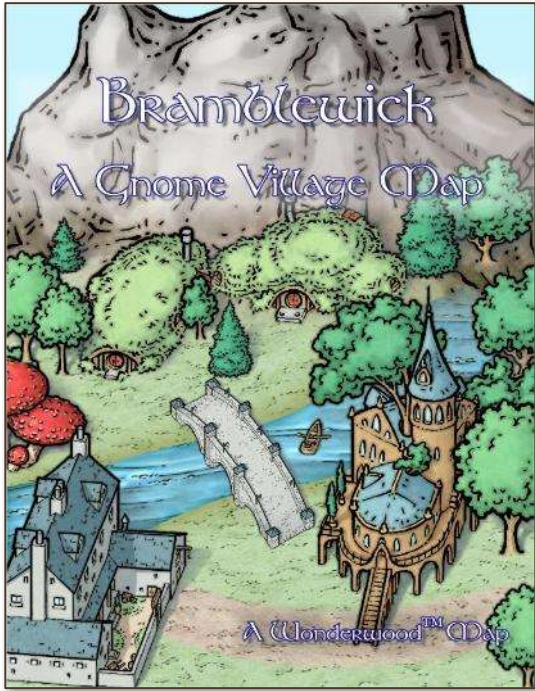

Welcome to Bramblewick, a whimsical gnome village nestled among gentle hills, winding waterways, and towering trees. This richly detailed, top-down map brings to life a vibrant community of hill and forest gnomes, where burrow homes dot the hillsides, treehouses rise among the branches, and cottages grow from oversized mushrooms. Perfect for use as a fantasy town map, village map, or encounter map in Dungeons & Dragons, Pathfinder, and other tabletop RPGs.

- **Maps Included:** 1
- **Series:** Bramblewick, [Wonderwood](#)
- **Categories:** Cities & Towns, Wonderwood
- **Adventure Use:** Settlement
- **Keywords:** Gnome, Village, Wonderwood, Observatory, Mushroom Cottage, Treehouse, Burrow

Price: \$2.99

Map Size: 600 x 600 feet

Size of Files: 1,343.7 MB

Published: April 7, 2026

[DTRPG #563148](#)



Bramblewick Samples



Bramblewick Village



*Clocktower in the
Market Square*



Temple and Park



*Observatory on
Starspire Summit*

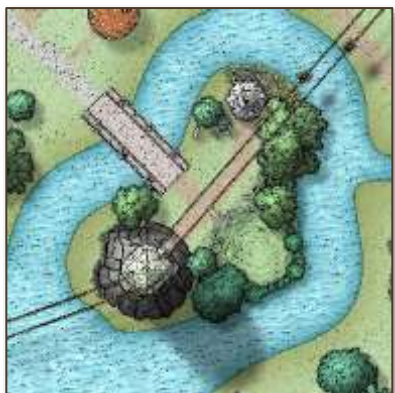

*Lantern Isle and the
Village Druid*

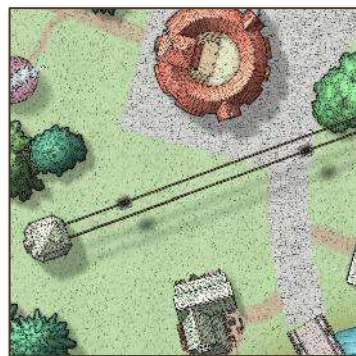

*Gondola Rides to
Starspire Summit*



*Forest Gnome
Treehouses*



Hill Gnome Burrows

Bramblewick Floorplans

Step Inside the Homes of Bramblewick

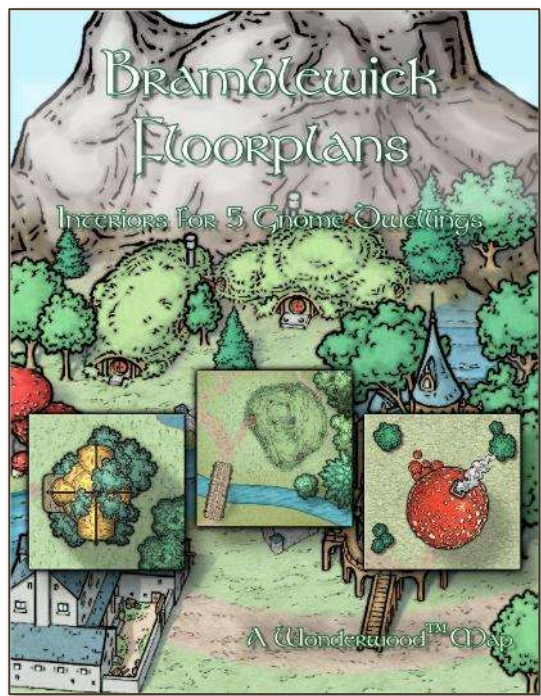

Bring the whimsical village of Bramblewick to life with this collection of detailed interior maps, designed to expand your adventures beyond the village streets and into the homes, halls, and hidden spaces within. This supplement provides fully realized floorplans for five key locations in Bramblewick, a charming gnome village of burrow homes, treehouses, and mushroom cottages. Whether your players are visiting a cozy residence, investigating a mystery, or navigating magical chaos, these maps offer rich, ready-to-use environments for your tabletop sessions. Includes floorplans for a mushroom cottage, a rock gnome burrow, a forest gnome treehouse, a druid's burrow, and a mage's treehouse.

- **Maps Included:** 20
- **Series:** Bramblewick, [Wonderwood](#)
- **Categories:** Cities & Towns, Wonderwood
- **Adventure Use:** Settlement
- **Keywords:** Gnome, Interior Maps, Treehouse, Burrow, Mage Tower, Druid, Mushroom Cottage

Price: \$2.99

Map Size: 40 x 40; 80 x 80;
120 x 80

Size of Files: 280.14 MB

Published: April 24, 2026

[DTRPG #565324](#)



Bramblewick Floorplans Samples



Treehouse, Floor 1



Burrow, Floor 1



Druid Burrow, Floor 1



*Mage Treehouse,
Floor 1*



*Mushroom Cottage,
Floor 1*



Burrow, Basement

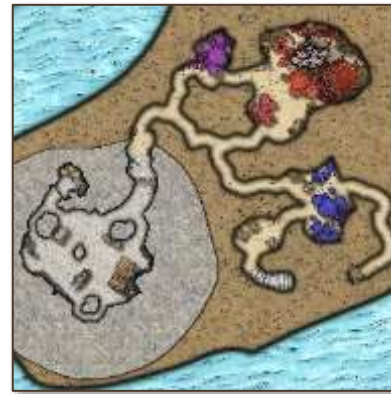

*Druid Burrow,
Basement*



*Mage Treehouse,
Floor 2*

Coastal Fortress

A Fortress at the Edge of the Sea

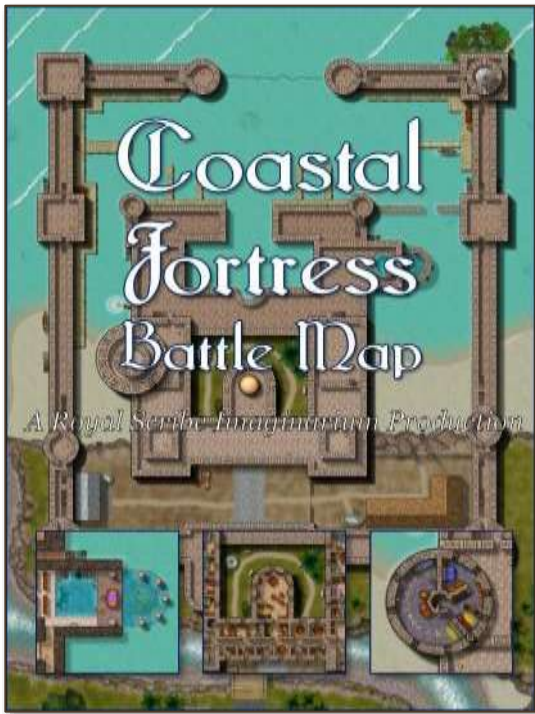

A mighty fortress stands where river meets sea. Protected by towering walls, harbor defenses, and a vigilant lighthouse, the Coastal Fortress serves as a noble residence, military stronghold, center of government, religious sanctuary, and arcane bastion all in one. Whether your players arrive as honored guests, desperate defenders, daring infiltrators, or invading conquerors, this massive multi-level location is designed to support countless adventures. From the harbor docks and sea walls below to the summoning chamber atop the mage's tower, every level of the fortress has been carefully designed to feel both believable and adventure-ready.

- **Maps Included:** 8 levels
- **Series:** Standalone Product
- **Categories:** Castles & Fortresses, Coastal Adventures
- **Adventure Use:** Stronghold
- **Keywords:** Harbor, Military, Lighthouse, Government, Mage Tower, Sewers, Prisons, Maritime

Price: \$7.99

Map Size: 520 x 600 feet

Size of Files: 7,363.34 MB

Published: June 12, 2026

[DTRPG #571755](#)



Coastal Fortress Samples



Above



Level 1



Level 4



Level 5



Chapel



Mage's Workshop



Sewers



Prison

Deserted Island

Shipwrecked. Stranded. Forgotten.

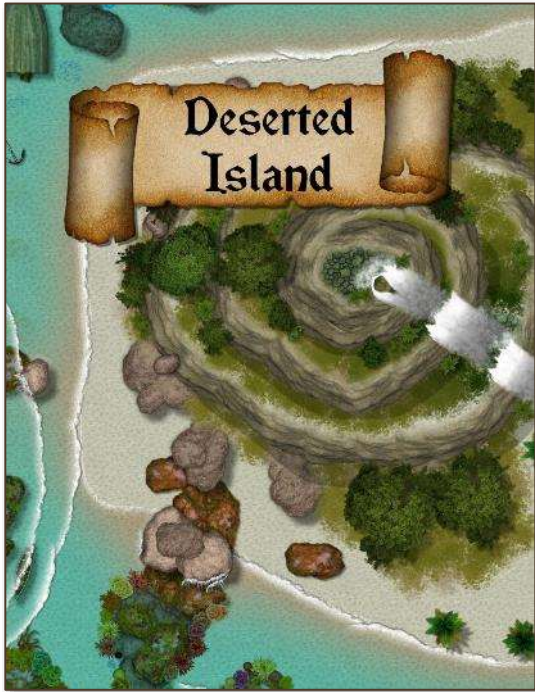

Price: \$1.99

Map Size: 320 x 280 feet

Size of Files: 615.77 MB

Published: June 23, 2026

[DTRPG #572691](#)

Deserted Island is a detailed tropical battlemap and VTT map designed for shipwreck adventures, pirate treasure hunts, wilderness exploration, and survival scenarios. Whether your adventurers are stranded after a storm at sea, searching for hidden treasure, investigating a mysterious cave, or simply making landfall during a larger coastal campaign, this versatile island map is ready for adventure. Rising above the island, a rocky hill crowned by a freshwater basin spills into a cascading waterfall that provides a vital source of fresh water for castaways and explorers alike. Surrounded by coral reefs and rocky outcroppings, the island features white-sand beaches, lush tropical vegetation, a freshwater stream, abundant marine life, a hidden cave entrance, a sunken canoe, and the remains of a wrecked ship resting beneath the waves. The map can serve equally well as a castaway survival challenge, a pirate hideout, a monster lair, a random wilderness encounter, or a destination in any coastal or nautical campaign.

- **Maps Included:** 2
- **Variants:** Treetops Shown/Hidden
- **Series:** Standalone Product
- **Categories:** Coastal Adventures, Wilderness Encounters
- **Adventure Use:** Travel Encounter
- **Keywords:** Island, Tropical, Shipwreck, Survival, Hidden Cave



Deserted Island Samples



Full island, trees shown



Sandy beaches



Shipwrecks



Fresh water



*Full island, treetops
hidden*



*Perilous sharks and
other predators*

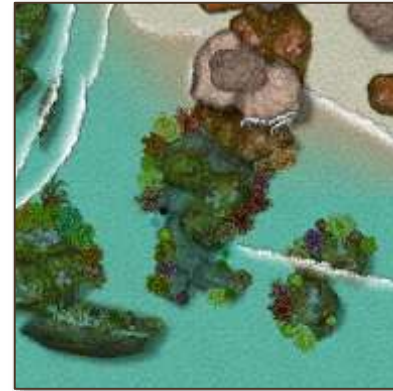

And a sunken canoe



A hidden cave

Drowned Sisters' Grotto

Beneath the Waves, the Sea Hag Coven Waits

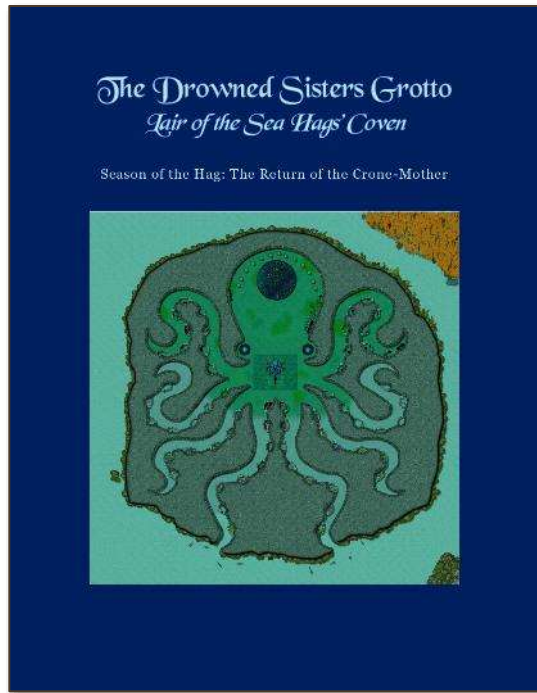

Price: \$4.99

Map Size: 720 x 720 feet

Size of Files: 563.13 MB

Published: Sept. 30, 2025

DTRPG #538326

Deep beneath the waves lies the Drowned Sisters' Grotto, a sprawling underwater lair carved long ago by intelligent octopi and now claimed by a coven of three sea hags. Here they scheme, feast, and weave the rituals of the Crone-Mother.

Map Guide includes extensive background lore as well as homebrewed character classes and tables of strange and bizarre treasures.

- **Maps Included:** 2 levels
- **Series:** [Season of the Hag](#)
- **Bundles:** [Rise of the Crone-Mother Bundle](#)
- **Categories:** Coastal Adventures, Season of the Hag
- **Adventure Use:** Dungeon Crawl
- **Keywords:** Sea Hag, Underwater, Coven, Crone-Mother, Homebrew



Drowned Sisters' Samples



Sea Hags' Lair, Above



Coven's Ritual Chamber

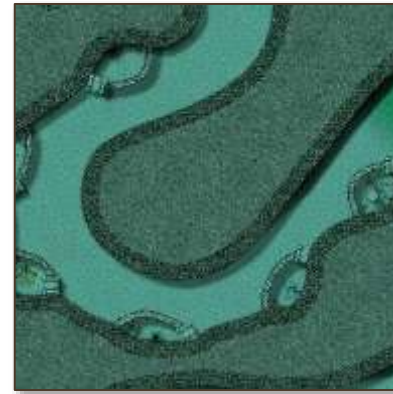

Mermaid in Captivity

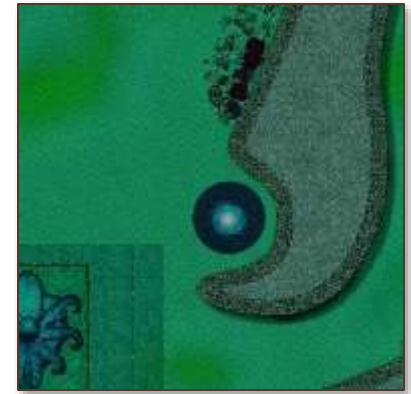

Teleportation Portal



Sea Hags' Lair, Inside

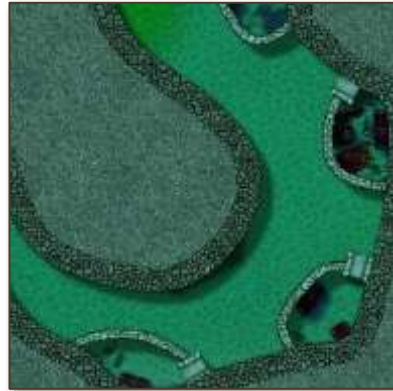

Bedrooms

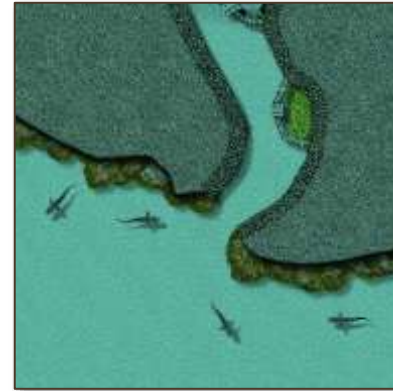

Sharks Guard the Entrances

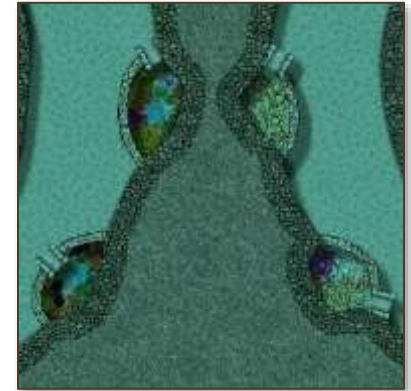

Underwater Gardens

Druid Henge

Planar Battlemaps Set (Material, Fey, Shadow)

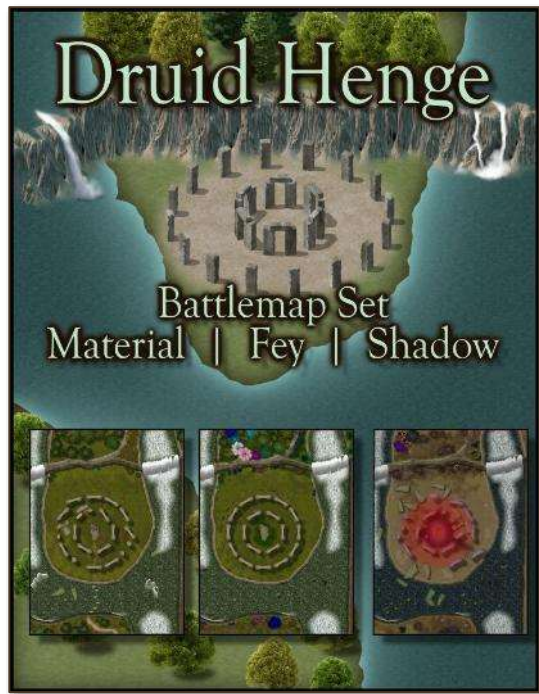

Price: \$2.99

Map Size: 240 x 320 feet

Size of Files: 807.9 MB

Published: May 5, 2026

[DTRPG #566680](#)

An ancient henge stands at the crossroads of three realities. This battlemap set presents three versions of the same druidic site, each shaped by a different plane of existence: the grounded Material Plane, the vibrant Fey Realm, and the corrupted Shadow Realm. Use each map on its own or link them together as a planar nexus, allowing your players to step between worlds where the same place exists in radically different forms.

- **Maps Included:** 3 variants
- **Variants:** Material Plane, Fey, Shadow
- **Series:** Standalone Product
- **Categories:** Ruins & Landmarks, Temples & Churches
- **Adventure Use:** Planar
- **Keywords:** Feywild, Shadowfell, Druidic, Portal, Planar Travel, Divine, Religious



Druid Henge Samples



Material Plane



Fey



Shadow



*Perfect henge stones of
the Fey*



Lush, exotic fey foliage

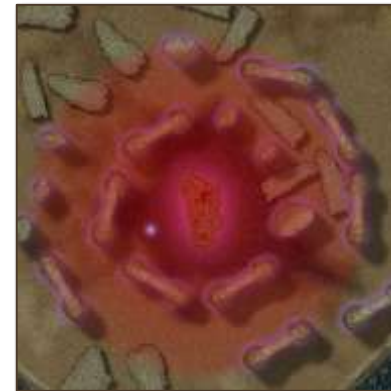

*Broken, corrupted
henge in Shadowfell*



*Shadowed gardens are
withered and lethal*

Forest Temple Ruins

Forgotten Gods Beneath the Forest Canopy

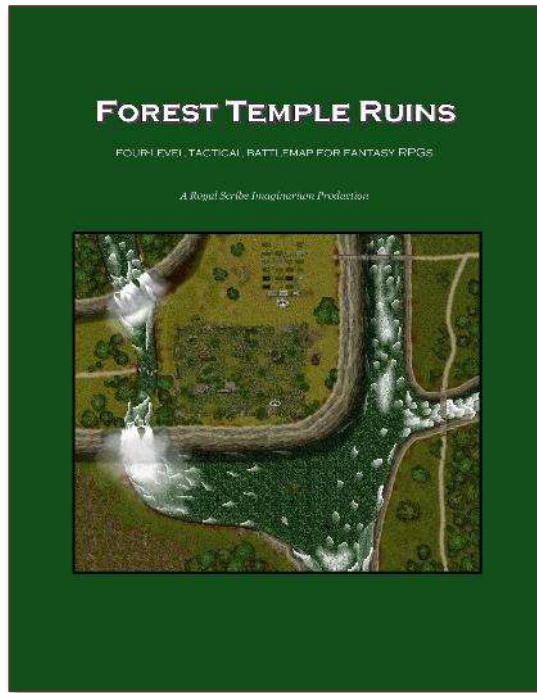

Uncover the mysteries of an ancient temple hidden deep in the forest – a place where broken stone walls, moss-covered statues, and shadowy crypts whisper of forgotten gods. Beneath the shattered sanctuary lie forgotten crypts, hidden tombs, and ancient passages reclaimed by roots and time. Whether the temple once honored a benevolent deity or concealed darker secrets is for your players to discover.

Whether your adventurers stumble upon the ruins by chance or seek them out for their secrets, these maps bring the setting to life for any fantasy RPG system.

- **Maps Included:** 6 levels/variants
- **Variants:** Treetops Shown/Hidden, Secret Areas Shown/Hidden
- **Series:** Standalone Product
- **Categories:** Dungeons & Caverns, Ruins & Landmarks
- **Adventure Use:** Ruins
- **Keywords:** Temple, Forest, Were-Serpents, Homebrew, Religious, Divine

Price: \$3.99

Map Size: 480 x 400;
320 x 280

Size of Files: 3,470.62 MB

Published: Sept. 16, 2025

DTRPG #536290



Forest Temple Ruins Samples



Deep in the forest, the ruins of a temple



A cult has occupied the basement



Deeper still, prisons and a crypt

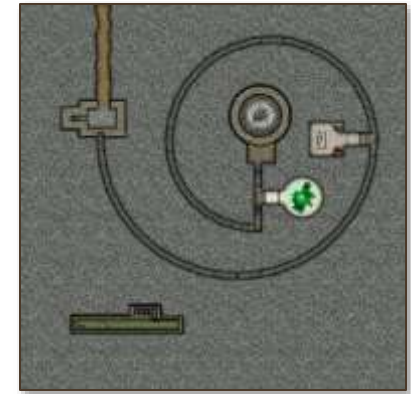

Secret stairs wind deep underground



Closer look at the ruins



What secrets lie in those tombs?



The secrets revealed



The hidden tomb of a forgotten hero

Frostmaidens' Cradle

In the icy mountain peaks, the Alpine Hags shriek and wail

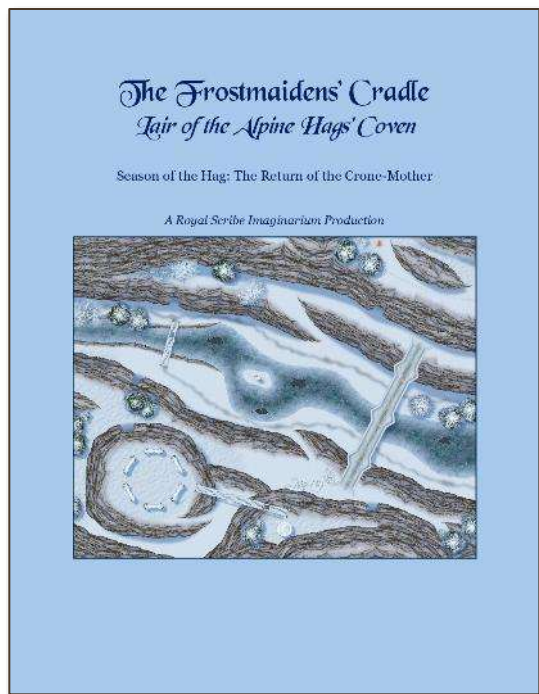

High in the jagged peaks where the wind cuts like glass, three winter hags weave their blizzards of malice. Frostmaidens' Cradle reveals their mountain stronghold – an ancient dwarven outpost entombed in ice and twisted by dark magic. Beneath these frozen caverns, the white dragon's bones lie in silence...and the Frostmaidens whisper their cruel plans to awaken a power older than winter itself. Use this map pack to drop a ready-to-run alpine lair into any fantasy campaign or use it as the fourth chapter in the Season of the Hag series. Whether your heroes come seeking the stolen warmth of spring, a lost dwarven relic, or vengeance for a frozen village, the Frostmaidens wait.

- **Maps Included:** 3 levels
- **Series:** [Season of the Hag](#)
- **Bundles:** [Rise of the Crone-Mother Bundle](#)
- **Categories:** Dungeons & Caverns, Season of the Hag, Winter Adventures
- **Adventure Use:** Dungeon Crawl
- **Keywords:** Winter Hag, Ice Caverns, Dragon Bones, Homebrew, Crone-Mother

Price: \$4.99

Map Size: 400 x 320 feet

Size of Files: 1,509.72 MB

Published: Oct. 22, 2025

[DTRPG #541685](#)



Frostmaidens' Samples

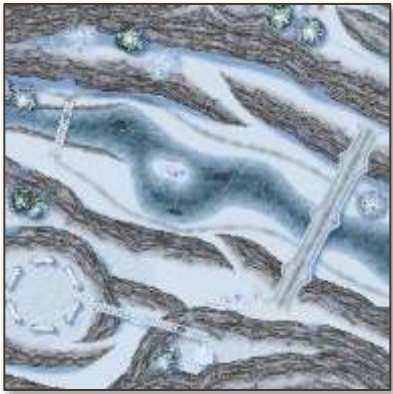

Above the Alpine Hags' Icy Lair

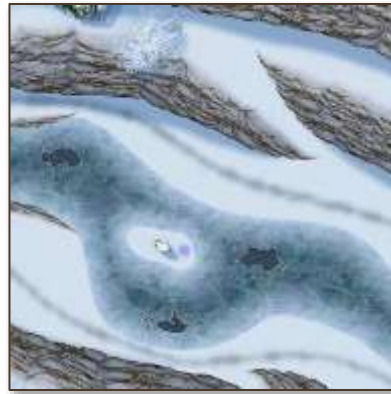

A mysterious pillar in an icy river



Inside the Upper Caverns



Inside the Lower Caverns



An icy bridge spans the frozen river



A dragon's bones are imprisoned in ice



The personal quarters of one of the hags



The remnants of a dwarven shrine

Greco-Roman Temple

Where Faith and Empires Endure

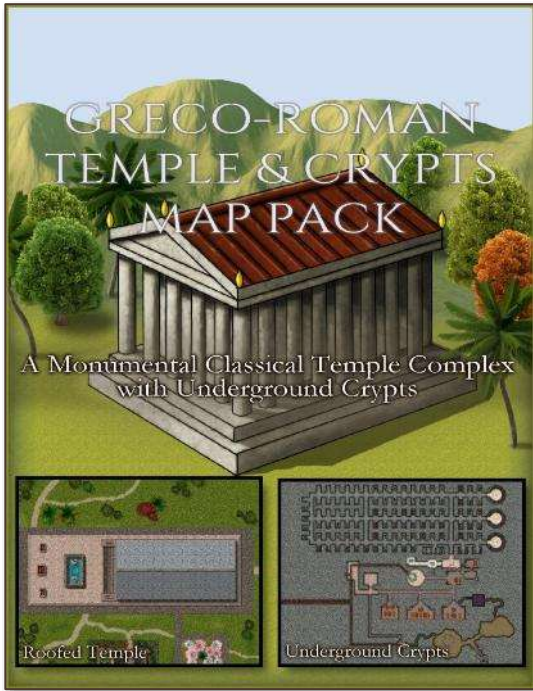

A monumental classical temple complex inspired by Greek and Roman architecture, complete with extensive underground crypts, including sealed vaults, columbaria, hidden tunnels, and optional secret areas — perfect for dungeon exploration, mystery, and campaign-spanning plot threads.

This large-scale fantasy battlemap pack presents a 520 × 400 ft temple suitable for divine intrigue, political drama, sacred rites, dungeon exploration, or high-stakes confrontation. Designed for tabletop roleplaying games (TTRPGs), these system-neutral VTT maps and printable battlemaps blend historical inspiration with flexible adventure design.

- **Maps Included:** 4 levels/variants
- **Variants:** Secrets Shown/Hidden Underground
- **Series:** Standalone Product
- **Categories:** Temples & Churches
- **Adventure Use:** Temple
- **Keywords:** Classical, Crypts, Divine, Ancient, Greco-Roman, Religious

Price: \$2.99

Map Size: 520 x 400 feet

Size of Files: 1,541.43 MB

Published: Feb 17, 2026

[DTRPG #557463](#)



Greco-Roman Temple Samples



Above



Inside

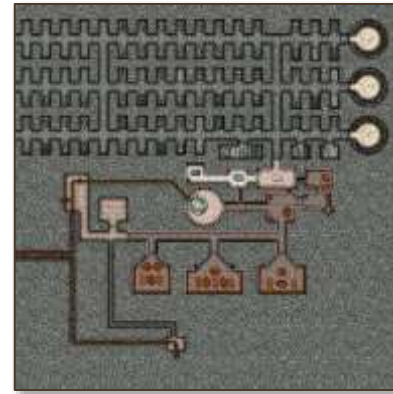

Underground, Secrets Hidden

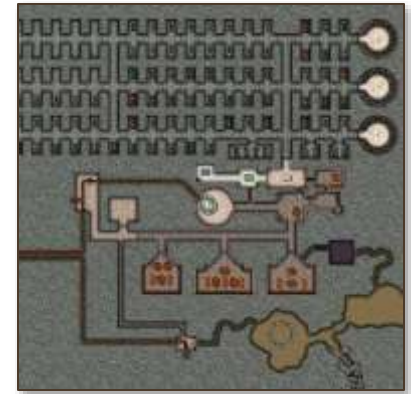

Underground, Secrets Shown



Fountains and the Offerings Fires



Wall Shrines, and the Great Statue

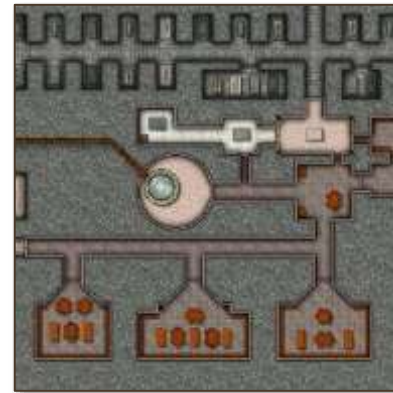

The priests' working space and archives



Peek inside the sarcophagi

Grotto of the Goddess of Love

A Hidden Sanctuary Blessed by the Sea

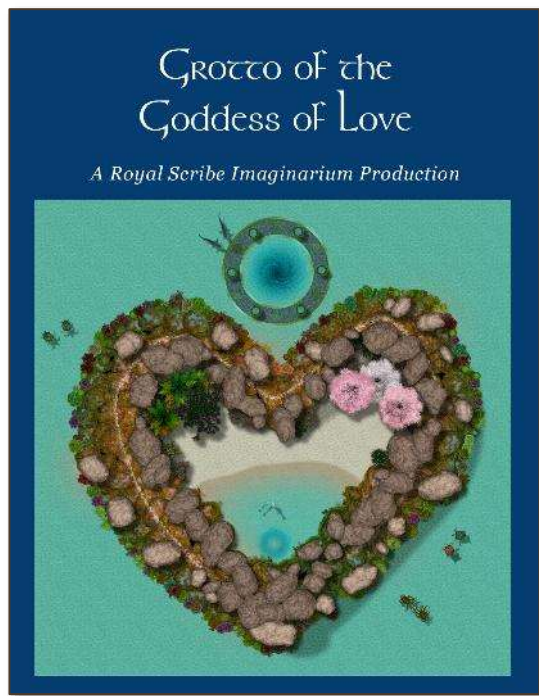

Price: PWYW

Map Size: 240 x 240 feet

Size of Files: 187.94 MB

Published: Sept. 2, 2025

[DTRPG #535090](#)

Hidden among crystalline seas lies a small heart-shaped island, sacred to the goddess of love. Steep cliffs and jagged rocks guard its shores, making it unreachable by mundane means. Instead, travelers must dive through an enchanted underwater portal to emerge within its sheltered sands. Inside the grotto, the air is filled with the fragrance of cherry blossoms and exotic fruits. Palm fronds sway gently in the sea breeze, while flowering bushes scatter bursts of pink across the island's edge. Couples of sea creatures – turtles, sharks, and octopi – circle the island in harmony, symbols of love's many forms.

- **Maps Included:** 1 level
- **Series:** Standalone Product
- **Categories:** Coastal Adventures, Temples & Churches
- **Adventure Use:** Temple
- **Keywords:** Love Goddess, Island Shrine, Sacred Site, Temple, Religious, Greco-Roman



Love Goddess Grotto Samples



*Love Goddess' shrine
protected refuge*



*Even the sea creatures
appear to be in love*

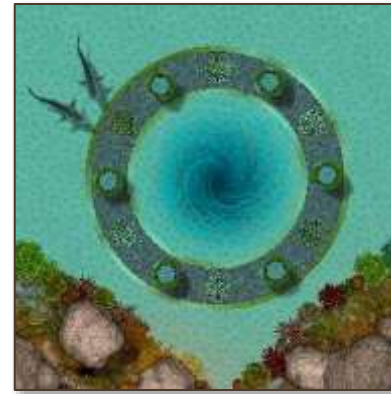

*Enter the Grotto
through a magical
vortex*

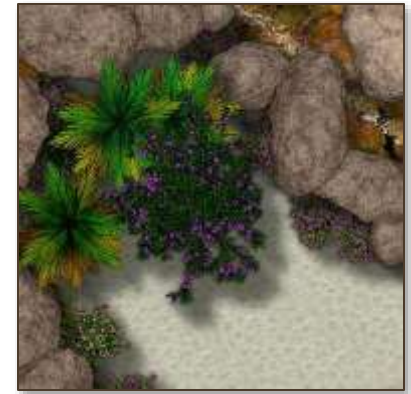

*Lush palm trees and
tropical fruits*

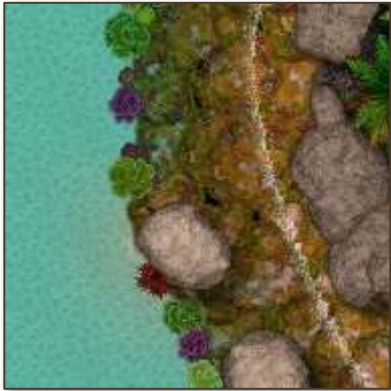

*Surrounded by coral-
encrusted cliffs*

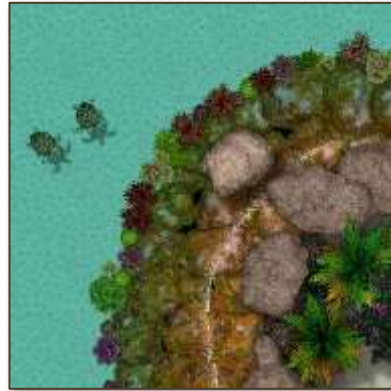

*Coupling up outside the
Grotto*



*Greeted by a pair of
mermaids*



*And exotic foliage like
cherry blossom trees*

Icy Ruins

Winter Has Buried Its Secrets Well

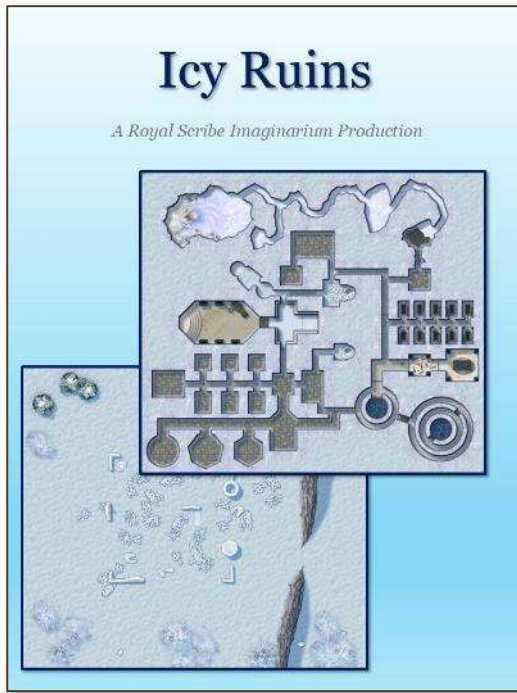

Price: \$2.99

Map Size: 320 x 280 feet

Size of Files: 529.93 MB

Published: Jan. 31, 2026

[DTRPG #555353](#)

Beneath the drifting snows of a frozen wilderness lie the icy ruins of an ancient temple, fortress, or outpost, long abandoned and half-buried by time and winter. Crumbling stone walls rise from the snow above, while forgotten halls, crypts, and caverns stretch below – preserved in ice and silence.

This two-level map set presents a versatile, system-neutral dungeon suitable for winter, mountain, or arctic campaigns. The upper level depicts snow-covered surface ruins, including collapsed walls and a grand, snow-choked staircase descending into the depths. Below, the subterranean level reveals frost-lined corridors, crypts with disturbed sarcophagi, ancient halls, and a breach into crystal-filled caverns that hint at deeper secrets...or the source of the unnatural cold itself.

- **Maps Included:** 2 levels
- **Series:** Standalone Product
- **Categories:** Dungeons & Caverns, Ruins & Landmarks, Winter Adventures
- **Adventure Use:** Ruins
- **Keywords:** Winter, Arctic, Crypts, Frozen Temple



Icy Ruins Samples

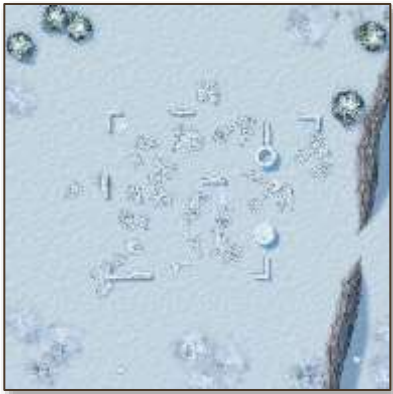

Ruins from above

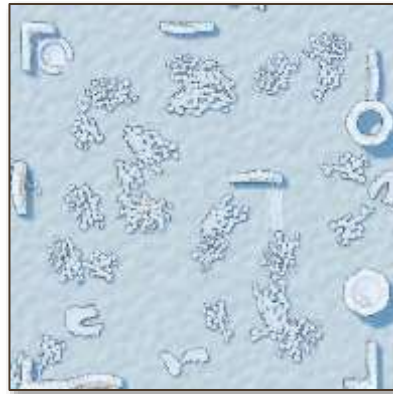

Adventures can dig out the snow to descend

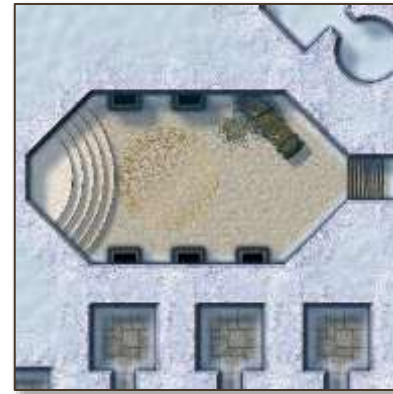

A throne room with dwarven architecture

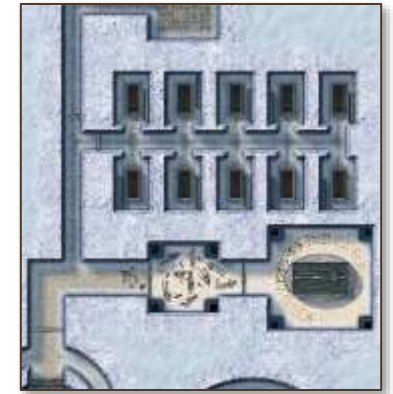

Skeletons from the crypts outside the Tomb

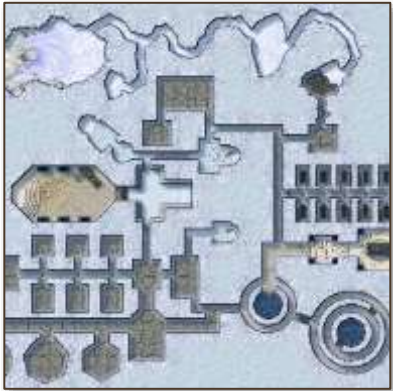

Inside the ruins below



The stairs descend to snow-covered rooms

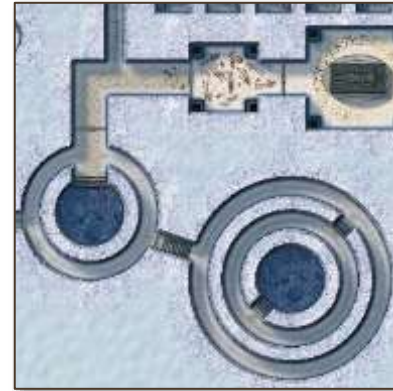

Even the geothermal pools are iced over

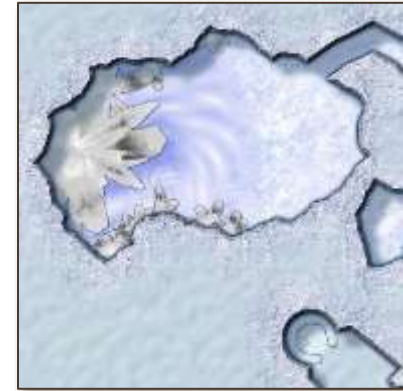

The arcane source of this icy curse?

Lighthouse Battlemat

Where the Beacon Meets the Storm

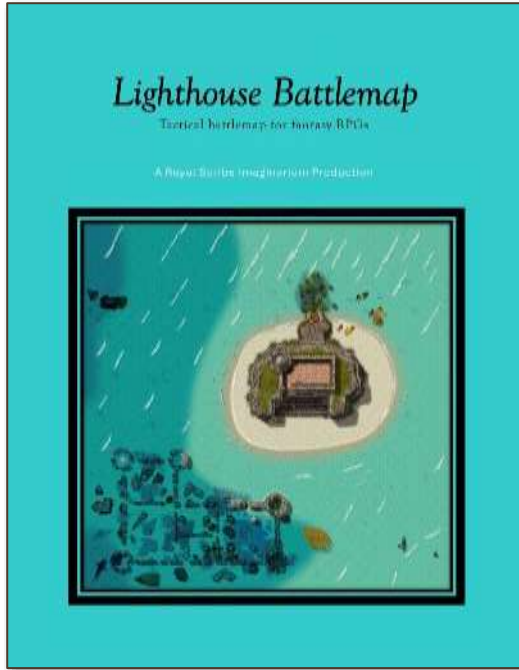

Price: \$3.99

Map Size: 480 x 480; 160 x 160

Size of Files: 1,304.9 MB

Published: Sept. 16, 2025

DTRPG #536986

Perched high atop storm-lashed cliffs, this fortified lighthouse commands both land and sea. Within its stone walls lie storied chambers, hidden shrines, and perilous secrets. Offshore, shattered ruins and a glowing vortex beckon adventurers into the depths.

Will your heroes defend the light, or discover what lurks beneath the waves?

- **Maps Included:** 6 levels
- **Series:** Standalone Product
- **Categories:** Coastal Adventures, Ruins & Landmarks
- **Adventure Use:** Stronghold
- **Keywords:** Lighthouse, Coastal, Underwater Ruins, Vortex



Lighthouse Battlemap Samples



Full lighthouse from above



Lighthouse and Island above



Lighthouse Tower



Lighthouse Basement

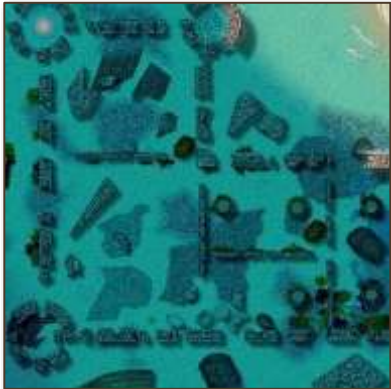

Ruins of a now-submerged citadel



Just the fortified lighthouse



Within part of the lighthouse tower



Deeper underneath the lighthouse

Mapleford Church

The Heart of a Village Community

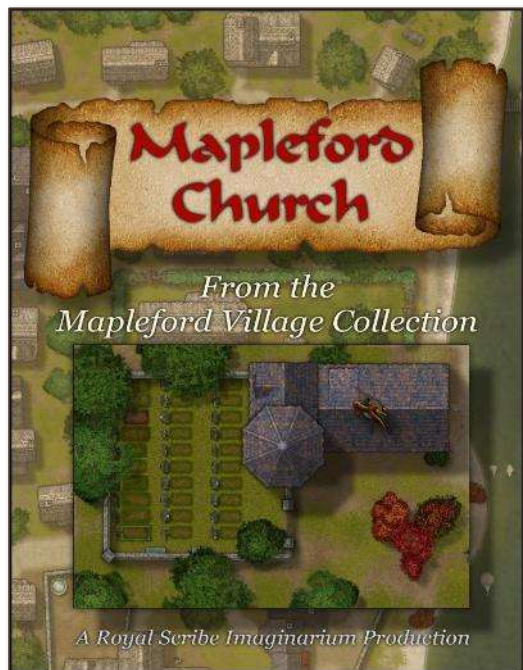

Price: \$1.99

Map Size: 120 x 80

Size of Files: 199.32 MB

Published: March 23, 2026

[DTRPG #561480](#)

Bring your village to life with a fully realized rural church – complete with interior, bell tower, and crypt.

Mapleford Church Map Pack expands the Mapleford Village setting with a detailed stone church and surrounding graveyard, designed for seamless use in both VTT and print play. Whether your players seek sanctuary, investigate a mystery, or confront something stirring beneath the earth, this location provides a grounded and versatile setting for your campaign.

This map pack is not included in the [Mapleford Bundle](#).

- **Maps Included:** 4 levels
- **Series:** [Mapleford](#)
- **Categories:** Cities & Towns, Floorplans, Mapleford, Temples & Churches
- **Adventure Use:** Temple
- **Keywords:** Village Church, Graveyard, Crypt



Mapleford Church Samples



Church from Above



First Floor



*Second Floor: Bell
Tower*



Basement and Crypts



Graveyard



Altar and Nave

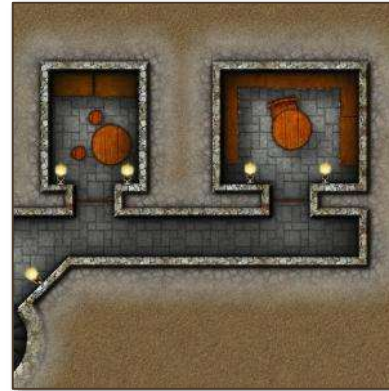

Sacristy and Archives



Crypts

Mapleford Market Square

Where Every Journey Begins

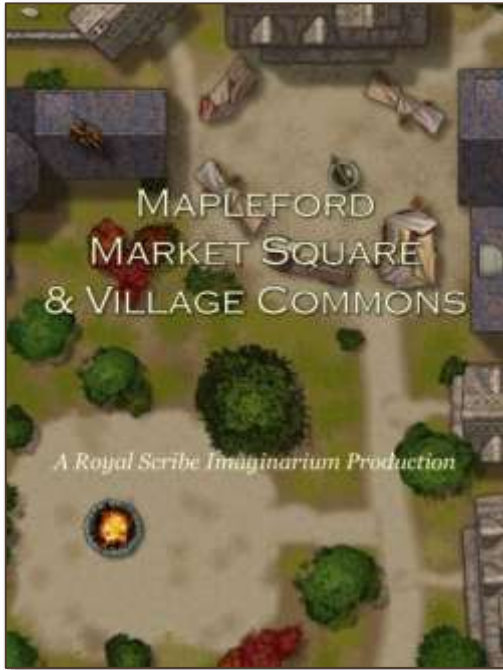

Price: PWYW

Map Size: 160 x 200

Size of Files: 165.08 MB

Published: May 30, 2026

[DTRPG #561924](#)

Mapleford Market Square is a detailed village hub designed for immediate use in your tabletop RPG sessions. Whether your players are trading goods, gathering rumors, or caught in the middle of unexpected danger, this map provides a flexible and dynamic setting for your campaign.

This product is offered as Pay What You Want – download it for free, or support future releases by paying what you feel it is worth.

- **Maps Included:** 1
- **Series:** [Mapleford](#)
- **Categories:** Cities & Towns, Mapleford
- **Adventure Use:** Settlement
- **Keywords:** Market, Village, Social Hub



Mapleford Market Square Samples



*Market Square
and Village
Commons*



*Market Square
with Church,
General Store,
Village Hall,
and market
stalls*



Village Commons



*Bonfire and the
Great Pine Tree*

Mapleford & Inn (Holiday)

Mapleford Village and the Candle & Kettle Inn (Holiday Edition)

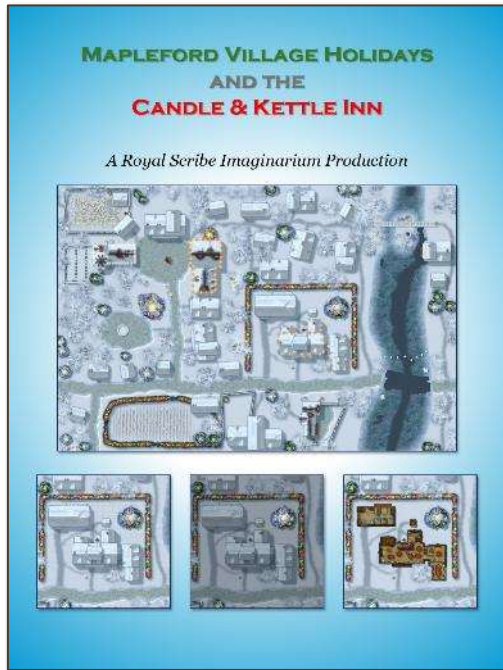

Welcome to Mapleford – a cozy riverside village dressed in winter finery, where lantern light glows against fresh snow and evergreen boughs are strung with festive lights.

This Holiday Edition transforms Mapleford into a seasonal celebration, perfect for winter festivals, solstice rites, yuletide feasts, or quieter moments of warmth and reflection between adventures. Designed to pair seamlessly with the Mapleford Village (Summer) and Mapleford Village (Winter) map packs, this release focuses on atmosphere, celebration, and visual storytelling.

This map pack is included in the [Mapleford Bundle](#).

- **Maps Included:** 2; 2
- **Variants:** Daytime and Dusk
- **Series:** [Mapleford](#)
- **Bundles:** [Mapleford](#)
- **Categories:** Cities & Towns, Mapleford, Winter Adventures
- **Adventure Use:** Settlement
- **Keywords:** Village, Inn, Home Base, Winter, Yule, Winter Solstice, decorations, lights

Price: \$1.99

Map Size: 600 x 400;
240 x 200

Size of Files: 1,083.55 MB

Published: Dec. 16, 2025

DTRPG #549357



Mapleford & Inn (Holiday) Samples



Mapleford decorated with holiday lights



Village Hall decorated with red and gold



Church decorated with white lights

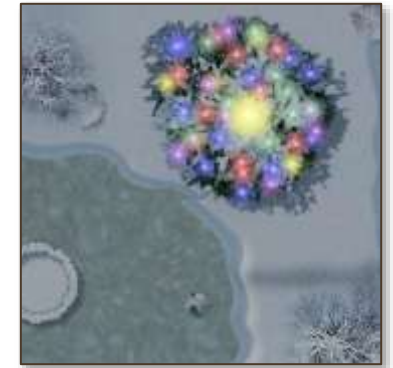

Great Pine decorated with a snowman



Candle & Kettle Inn holiday decorations



Even the hedge has lights



Holiday tree, and boughs on fireplaces



Candles lit in every window

Mapleford & Inn (Summer)

Mapleford Village and the Candle & Kettle Inn (Summer)

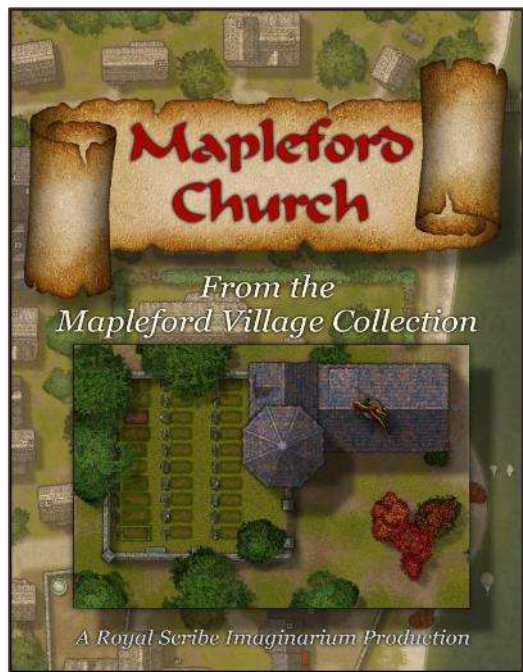

Welcome to Mapleford – a cozy riverside village perfect for adventurers. This map pack presents the summer edition of Mapleford, a humble settlement built around its shallow ford and surrounded by orchards, gardens, and a patchwork of rural life. Whether your players are passing through, putting down temporary roots, or unraveling mysteries beneath its quiet charm, Mapleford serves as a versatile home base for any fantasy campaign.

At the heart of the village stands the Candle & Kettle Inn, a warm and welcoming establishment offering food, drink, social gatherings, and rooms for the weary. This pack includes the full exterior and complete multi-floor interior of the inn, ready to drop into any session.

This map pack is included in the [Mapleford Bundle](#).

- **Maps Included:** 2; 10
- **Variants:** Treetops Shown/Hidden; Secret Areas Shown/Hidden
- **Series:** [Mapleford](#)
- **Bundles:** [Mapleford](#)
- **Categories:** Cities & Towns, Mapleford
- **Adventure Use:** Settlement
- **Keywords:** Village, Inn, Home Base

Price: \$3.99

Map Size: 600 x 400;
240 x 200

Size of Files: 3,088.16 MB

Published: Dec. 2, 2025

DTRPG #548093



Mapleford & Inn (Summer) Samples



*Mapleford Village
(Western Side)*



*Mapleford Village
(Eastern Side)*



*Community stables and
blacksmith*



*Island shrine and
watermill*



Candle & Kettle Inn



Inn, First Floor



Inn, Second Floor



*Inn, Cellars &
Underground*

Mapleford & Inn (Winter)

Mapleford Village and the Candle & Kettle Inn (Winter)

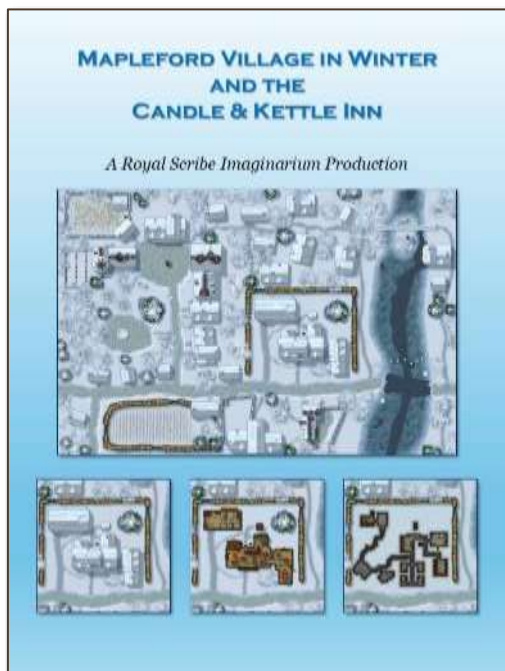

This map pack presents the winter edition of Mapleford, blanketed in snow and softened beneath the weight of cold-weather stillness. Frost gathers on rooftops, the river freezes along its edges, cracked ice forms at the ford, and lantern-lit paths wind through the drifts. Whether your players are seeking refuge from the cold, traveling in harsh weather, or returning to a familiar settlement changed by the passing season, Mapleford provides an inviting location for any winter adventure.

At the heart of the village stands the Candle & Kettle Inn, glowing warmly against the frozen landscape. Includes the full exterior grounds and complete multi-floor interior of the inn, now reimagined for winter with snowy hedges, icy walkways, and frosted surroundings.

This map pack is included in the [Mapleford Bundle](#).

- **Maps Included:** 2; 10
- **Variants:** Treetops Shown/Hidden; Secret Areas Shown/Hidden
- **Series:** [Mapleford](#)
- **Bundles:** [Mapleford](#)
- **Categories:** Cities & Towns, Mapleford, Winter Adventures
- **Adventure Use:** Settlement
- **Keywords:** Village, Inn, Home Base, Winter, Snow

Price: \$3.99

Map Size: 600 x 400;
240 x 200

Size of Files: 1,226.38 MB

Published: Dec. 10, 2025

DTRPG #548983



Mapleford & Inn (Winter) Samples



*Mapleford Village
(Western Side)*



*Mapleford Village
(Eastern Side)*



Frozen farms



Icy ford



Candle & Kettle Inn



Inn, First Floor



Inn, Third Floor



*Inn, Cellars &
Underground*

Miremothers' Den

The Marsh Has Mothers of Its Own

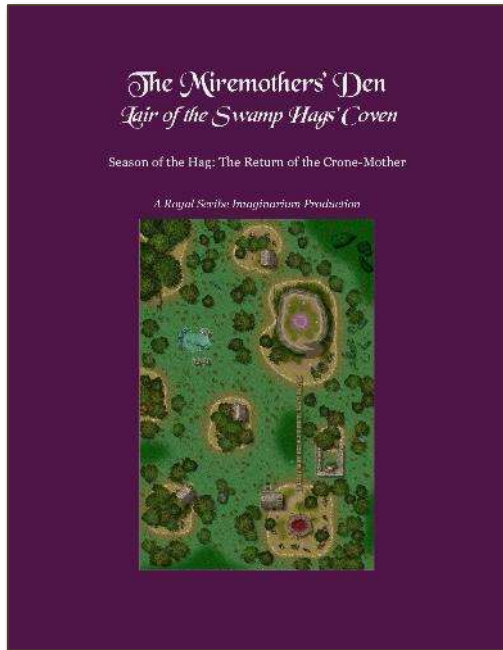

Price: \$4.99

Map Size: 320 x 480 feet

Size of Files: 1,979.77 MB

Published: Oct. 17, 2025

[DTRPG #540599](#)

In the choking heart of the marsh, where roots twist like serpents and the mist never lifts, three hags – Slytha the Mireheart, Grumma Rotbelly, and Nerrith the Stillborn – rule their drowned dominion. Together, they are known as the Miremothers, and their lair festers atop a maze of half-sunken ruins and islands of rot. Here they breed crocodiles in pens of bone, imprison captives in living mud, and chant beneath the watchful gaze of the Bog Skull, their talisman of power and decay.

Miremothers' Den is the third lair in the Rise of the Crone-Mother campaign series. It can be played as a standalone adventure or as part of the full saga, in which four covens of hags – of sea, forest, swamp, and frost – seek to resurrect the primordial Crone-Mother through ritual and sacrifice.

- **Maps Included:** 3
- **Variants:** Treetops Shown/Hidden
- **Series:** [Season of the Hag](#)
- **Bundles:** [Rise of the Crone-Mother Bundle](#)
- **Categories:** Season of the Hag
- **Adventure Use:** Dungeon Crawl
- **Keywords:** Swamp Hag, Marsh, Coven, Crone-Mother, Homebrew



Miremothers' Den Samples



*Miremothers' Den,
Northside*



*Miremothers' Den,
Southside*



*Beneath the trees and
elevated huts*



Inside the hags' huts



*Ancient ruins older
than the hags' lair*



*The hags' ritual hut and
bloody pool*



*Crocodile breeding pen
& Bridge of Bones*



Teleportation Portal

The Old San Francisco Mint

History's Granite Lady, Reimagined for Adventure

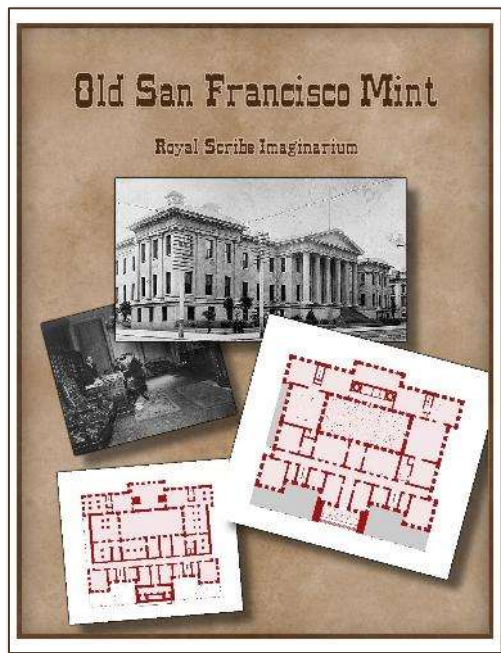

Known as the “Granite Lady,” the Old U.S. Mint at 5th and Mission Streets in San Francisco survived the 1906 Earthquake and Fire while guarding nearly one-third of the nation's gold reserves in its vaults.

Now you can bring this legendary building to your tabletop games. This system-neutral map pack provides four complete floors of the Mint, redrawn from historical blueprints in Campaign Cartographer 3, and adapted for easy use in any RPG setting. Use it as the actual Mint in a historical game, or reimagine it as a bank, a fortress, a museum, or a noble's mansion in your fantasy, historical, or modern campaigns.

- **Maps Included:** 4
- **Series:** Standalone Product
- **Categories:** Floorplans
- **Adventure Use:** Stronghold
- **Keywords:** Historical, Blueprint, Bank, Heist

Price: PWYW

Map Size: 320 x 280 feet

Size of Files: 1,546.18 MB

Published: Sept. 19, 2025

[DTRPG #537516](#)



Old SF Mint Samples

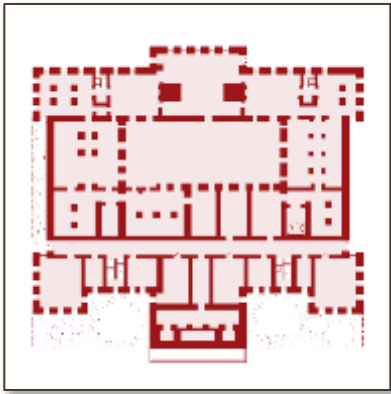

First Floor

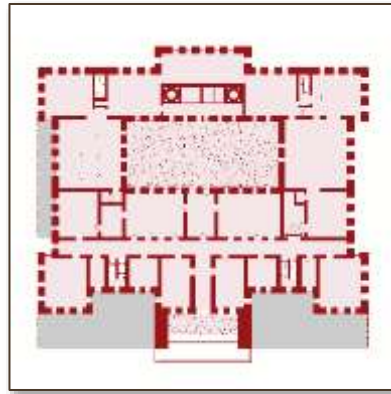

Second Floor: Main Entrance

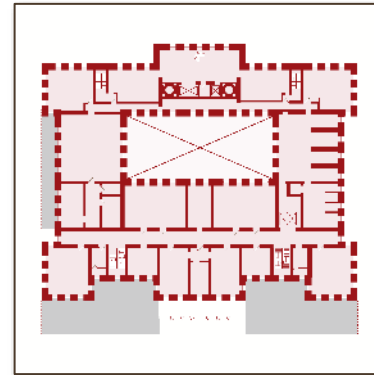

Third Floor

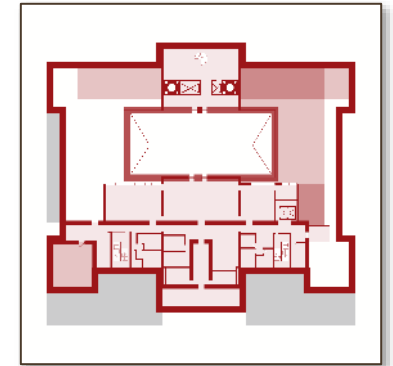

Fourth Floor



Fifth Street Entrance



Corner of 5th & Mission Streets



Inside the Mint when it was operational



Map of the Mint's Location

Rise of the Crone-Mother

Five Covens. One Dark Destiny.

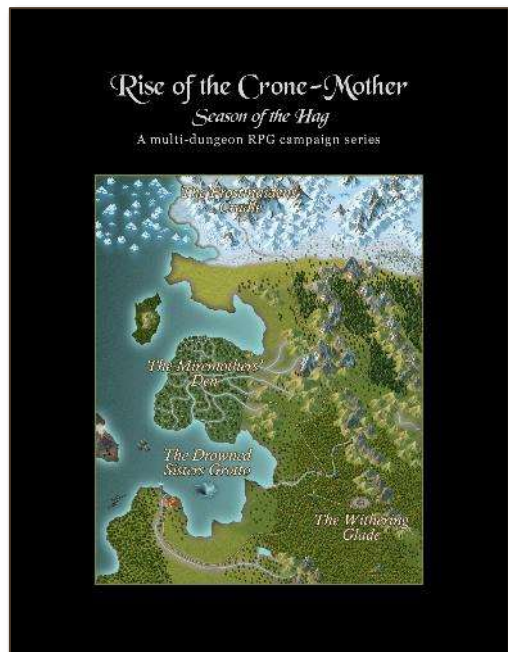

Price: PWYW

Map Size: 280 x 280 feet

Size of Files: 620.58 MB

Published: Sept. 30, 2025

[DTRPG #538321](#)

An interconnected saga of covens, talismans, and dark rebirth – perfect for the spooky season or any campaign steeped in horror.

Deep in shadowed forests, fetid swamps, storm-lashed peaks, and beneath the waves, four covens of hags scheme as one. At their head stands Mournvex, the Ashen Hag, who has united them in a single grand ritual: the resurrection of the Crone-Mother, the mythical progenitor of all hags.

Adventurers who stumble into their schemes may confront a single coven – or may pursue the witches across every lair, unraveling their growing power before it culminates in the volcanic Womb of Ashes.

- **Maps Included:** 2
- **Variants:** Broken Ice with Tentacles
- **Series:** [Season of the Hag](#)
- **Bundles:** [Rise of the Crone-Mother Bundle](#)
- **Categories:** Dungeons & Caverns, Season of the Hag
- **Adventure Use:** Campaign Arc, Dungeon Crawl
- **Keywords:** Hags, Campaign, Coven, Homebrew Classes



Crone-Mothers' Rise Samples



Travel over land to each hag coven...



...or use the Crone-Mother's web to teleport

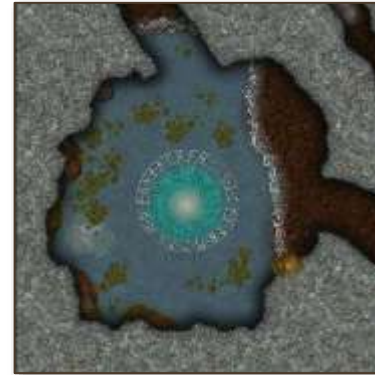

Portal to the Drowned Sisters' Grotto

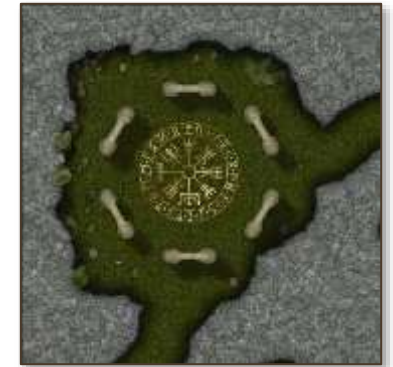

Portal to the Withering Glade

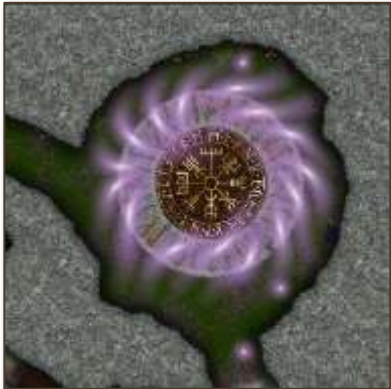

Portal to the Miremothers' Den



Portal to the Frostmaidens' Cradle



Beware what lurks beneath the ice

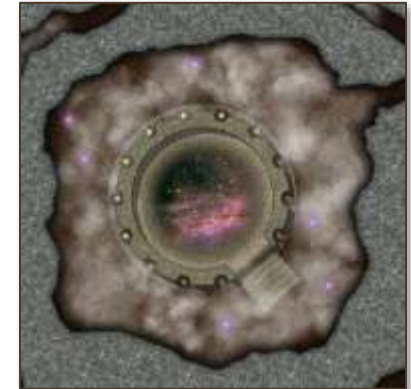

Portal to the Womb of Ashes

Royal Chapel

Where Faith, Crown, and Secrets Converge

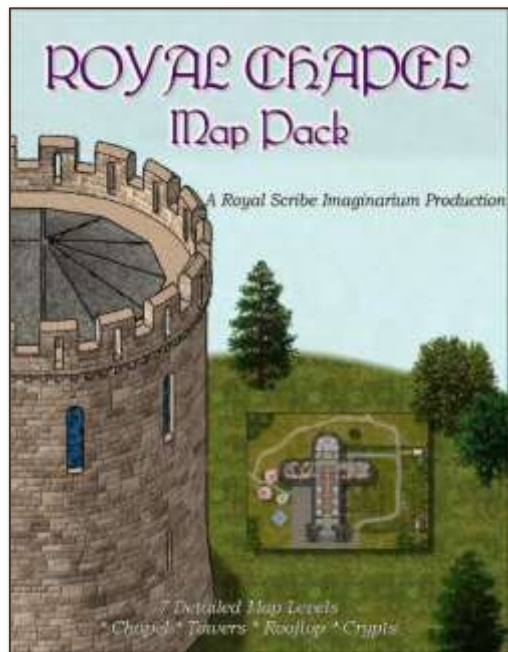

Price: \$3.49

Map Size: 320 x 240 feet

Size of Files: 1,546.18 MB

Published: March 17, 2026

[DTRPG #560874](#)

Step into a place of reverence, power, and buried secrets.

The Royal Chapel Map Pack presents a richly detailed, multi-level sacred complex designed for fantasy roleplaying games – from grand ceremonies in the chapel above to ancient tombs and hidden passages deep below.

Whether your players attend a royal wedding, investigate a missing relic, or uncover something that should have remained buried, this location is built to support memorable, story-driven play.

- **Maps Included:** 8
- **Variants:** Secrets Shown/Hidden
- **Series:** Standalone Product
- **Categories:** Temples & Churches
- **Adventure Use:** Temple
- **Keywords:** Royalty, Tombs, Crypts, Secret Passages



Royal Chapel Samples



Above the Royal Chapel



First Floor: Altar and Nave



Second Floor: Balcony Seating



Third Floor: Rooftop Parapets



Fourth Floor: Towers

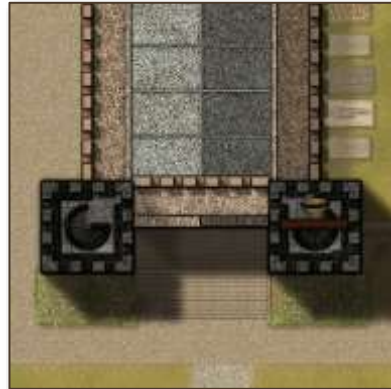

Fifth Floor: Bell Tower



Basement 1: Mercy Ward & Mortuary

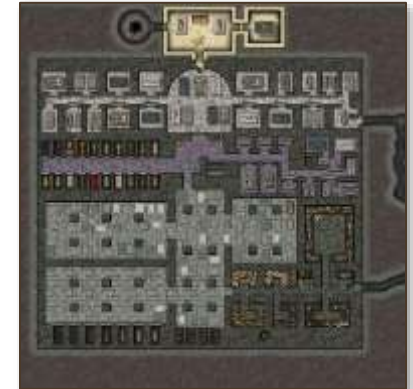

Basement 2: Crypts & Ossuary

Winter Wilderness

Every Road Is Dangerous After the First Snow

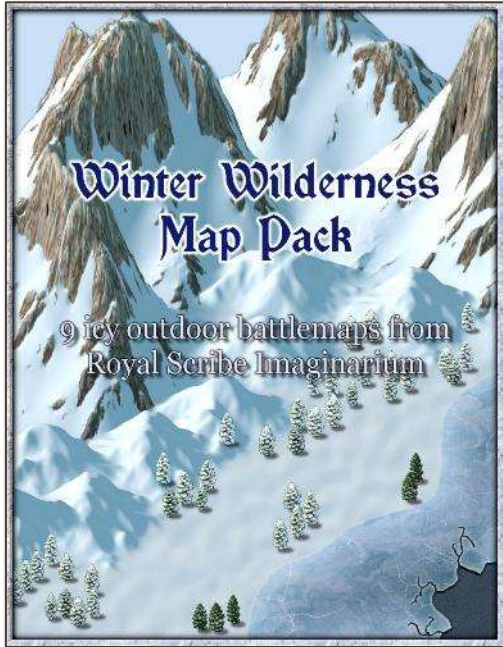

Price: \$2.39

Map Size: 320 x 280 feet

Size of Files: 4,351.57 MB

Published: Feb. 5, 2026

[DTRPG #555976](#)

Nine icy outdoor battlemaps for winter, arctic, and alpine adventures – designed for both Virtual Tabletops (VTTs) and print play. These maps are system-neutral, unlabeled, and free of built-in lore so you can drop them into any campaign whenever winter travel turns dangerous.

Several forest maps include two tree-cover variants: one with treetops visible and one with treetops hidden (showing trunks and canopy shadows), allowing creatures to move beneath dense branches while preserving the feel of a true winter forest.

- **Maps Included:** 16
- **Variants:** Treetops Shown/Hidden
- **Series:** Standalone Product
- **Categories:** Winter Adventures; Wilderness Encounters
- **Adventure Use:** Travel Encounter
- **Keywords:** Snow, Arctic, Travel, Overland



Winter Wilderness Samples

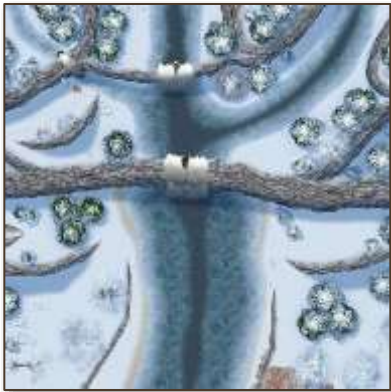

*Winter Waterfalls –
Trees Shown & Hidden*



*Frozen Lake ... with
Tentacles*



Icy Caverns, Below

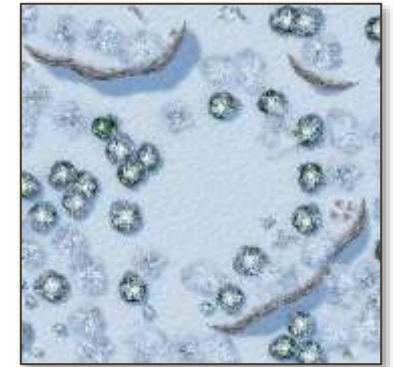

*Winter Forest Glade –
Trees Hidden & Shown*



*Winter Mountain
Canyon*

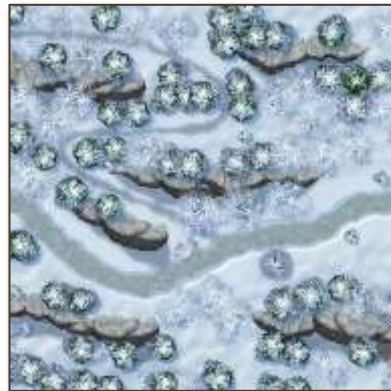

Winter Forest Road



River Path & Bridge

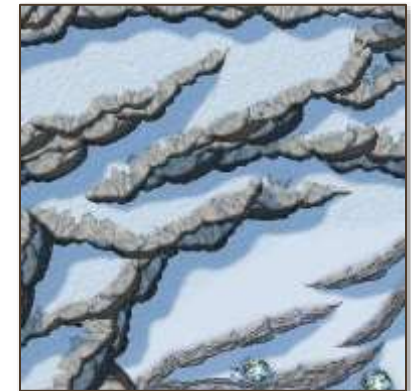

Arctic Cliffs

Withering Glade

Forest hags of rot and thorn

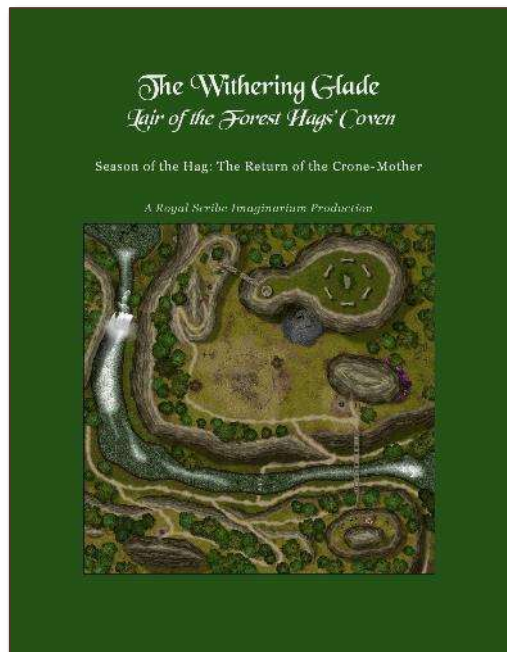

Price: \$4.99

Map Size: 480 x 480 feet

Size of Files: 3,000.41 MB

Published: Oct. 13, 2025

DTRPG #540015

Deep within an ancient forest where light dares not linger, three hags whisper their rot into root and leaf.

The Withering Glade was once a sacred elven grove, home to a towering oak and the spirit who tended it. Now, its heart is hollowed and poisoned, and the trees themselves seem to turn their branches away from the sun. The forest hags have twisted beauty into corruption, using thorn and bramble as both shield and snare. Each of the three sisters – Thestia the Briar-Witch, Ylsira the Rootbound, and Bramblemaw the Thorn-Tongue – rules her own hollow, each plotting to gain favor from their mistress, the Ashen Hag Mournvex, who seeks to bring about the rebirth of the Crone-Mother herself.

- **Maps Included:** 4
- **Variants:** Treetops Shown/Hidden
- **Series:** [Season of the Hag](#)
- **Bundles:** [Rise of the Crone-Mother Bundle](#)
- **Categories:** Dungeons & Caverns, Season of the Hag
- **Adventure Use:** Dungeon Crawl
- **Keywords:** Forest Hag, Corrupted Grove, Crone-Mother, Coven, Homebrew



Withering Glade Samples



Above the Withering Glade



Inside the upper caverns



Inside the lower caverns



The withered Olde Oak and corrupted dryad



The harpies' eyrie



Inside one hag's personal quarters



Prisoners tangled in clutching vines

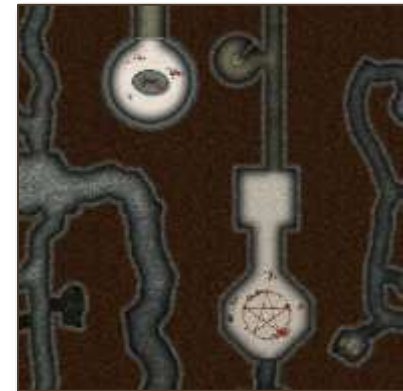

The hags' ritual chambers

Wizard's Tower

Arcane Secrets Rise One Floor at a Time

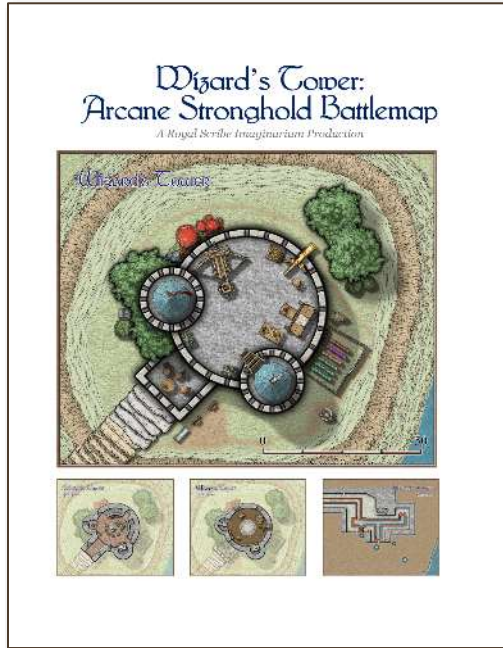

Price: \$5.99

Map Size: 120 x 100 feet

Size of Files: 396.12 MB

Published: August 26, 2025

DTRPG #534385

On nearly every fantasy map stands a solitary tower whose highest windows glow long after sunset. Is it a beacon of wisdom, a repository of dangerous magic, or the home of an unpredictable recluse? The Wizard's Tower Map Pack brings that timeless fantasy location to life with richly detailed interiors ready to become the stage for your own stories.

This richly detailed map set is perfect for dropping into any fantasy campaign. Whether your players are visiting a friendly archmage, infiltrating a rival's stronghold, or uncovering long-forgotten experiments, this tower is ready to become the centerpiece of your adventure.

- **Maps Included:** 7
- **Variants:** Secrets Shown/Hidden
- **Series:** [Wonderwood](#)
- **Categories:** Castles & Fortresses, Wonderwood
- **Adventure Use:** Stronghold
- **Keywords:** Wizard, Arcane, Mage Tower



Wizard's Tower Samples



Above the tower



First Floor: Audience Chamber



Second Floor: Kitchen & Dining, Balcony



Third Floor: Bedroom



Fourth Floor: Arcane Rituals Chamber

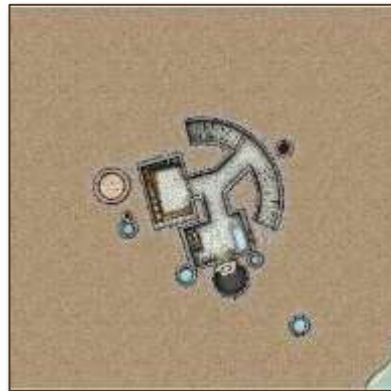

Basement 1: Secret Areas Hidden

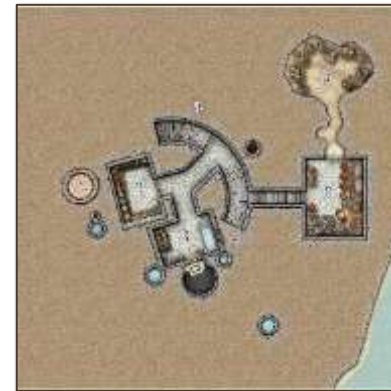

Basement 1: Secret Areas Shown

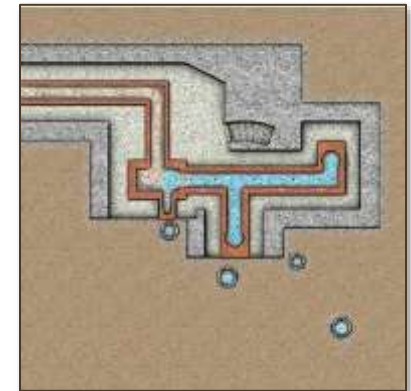

Basement 2: Sewers

Womb of Ashes

Where the Crone-Mother Shall Rise Again

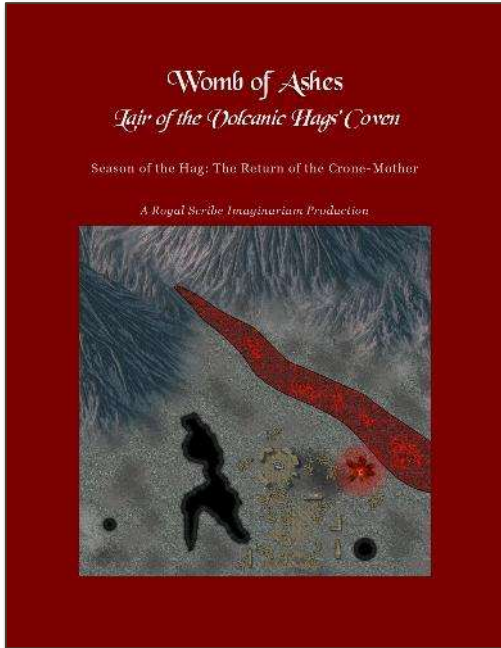

Price: \$4.99

Map Size: 320 x 320 feet

Size of Files: 779.41 MB

Published: Oct. 31, 2025

[DTRPG #544309](#)

Deep beneath a smoking volcano lies the Womb of Ashes, the final lair in the Season of the Hag series and the culmination of the Rise of the Crone-Mother saga. Here, five covens converge – sea, forest, swamp, alpine, and ash – to complete a ritual thirteen months in the making.

The air burns. The stone weeps. And if the ritual succeeds, a god-hag will walk the mortal world once more. This is the ultimate hag stronghold, a sprawling volcanic dungeon filled with ritual chambers, lava-lit caverns, and the ancient sigils of five elemental covens. Each level draws adventurers deeper toward the molten heart of the mountain – and the rebirth of something far older than witchcraft itself.

- **Maps Included:** 6
- **Series:** [Season of the Hag](#)
- **Bundles:** [Rise of the Crone-Mother Bundle](#)
- **Categories:** Dungeons & Caverns, Season of the Hag
- **Adventure Use:** Dungeon Crawl
- **Keywords:** Volcano, Hag, Finale, Crone-Mother, Homebrew



Womb of Ashes Samples



Above the volcanic lair

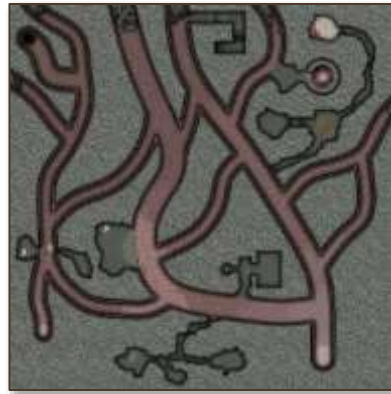

Descending to Level 1

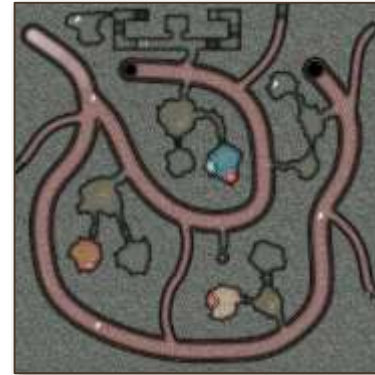

Level 2

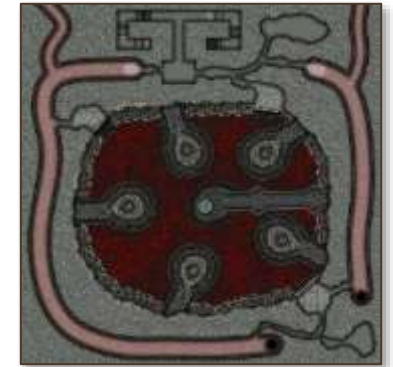

Level 3

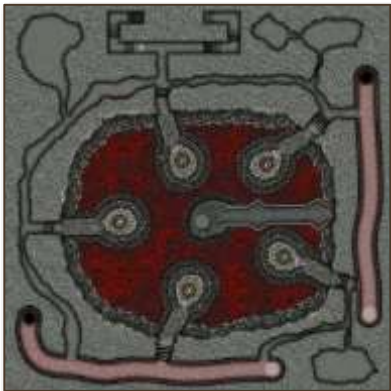

Level 4

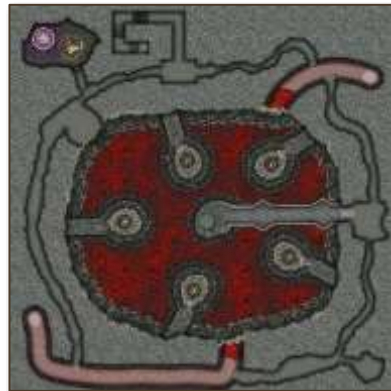

Level 5

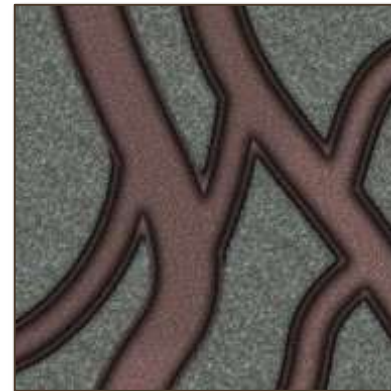

Many passageways are cooled lava tubes

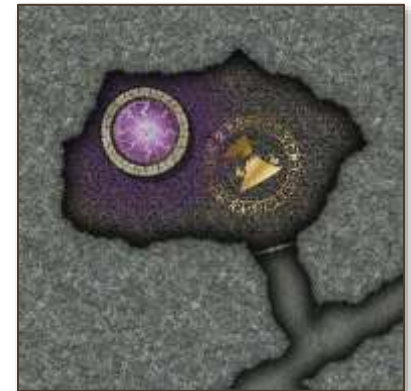

The Crone-Mother's revivication chamber

Bundles



Royal
Scribe
Imaginarium

Mapleford Bundle

A Cozy Riverside Village Across Three Seasons



Price: \$6.97 (30% off)

This bundle collects all three seasonal editions of Mapleford Village and the Candle & Kettle Inn into a single discounted package, giving you a flexible, reusable settlement you can drop into your campaign year-round.

Whether your adventurers arrive during high summer, brave the deep snows of winter, or find the village aglow with holiday lights, Mapleford is ready for play.

- [Mapleford Village & Candle & Kettle Inn \(Summer\)](#)
- [Mapleford Village & Candle & Kettle Inn \(Winter\)](#)
- [Mapleford Village & Candle & Kettle Inn \(Winter Holiday Edition\)](#)

[DTRPG #549781](#)



Rise of the Crone-Mother Bundle

Hag Covens United for a Dark Purpose

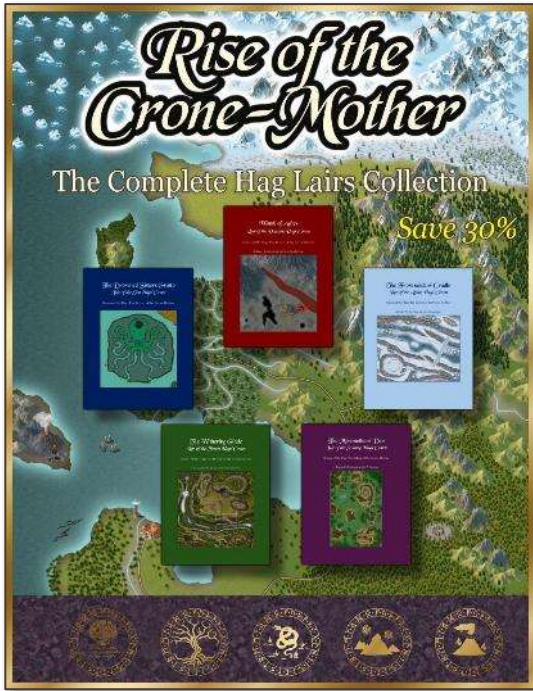

Price: \$17.45 (33% off)

Across sea, forest, swamp, mountain, and flame, thirteen hags weave a single terrible design – a ritual meant to awaken the Crone-Mother and unite hags throughout the world in one Grand Coven. This bundle gathers every lair in the series, each crafted with lavish multi-level maps, detailed environmental rules, adventure hooks, extensive homebrewed options, and GM aids.

- **Drowned Sisters' Grotto**: Lair of the Sea Hags
- **Withering Glade**: Lair of the Forest Hags
- **Miremothers' Den**: Lair of the Swamp Hags
- **Frostmaidens' Cradle**: Lair of the Alpine Hags
- **Womb of Ashes**: The volcanic heart of the coven
- **Rise of the Crone-Mother**: Free/PWYW Campaign Guide linking all five lairs to unify the adventures

[DTRPG #544465](#)



Categories



Royal
Scribe
Imaginarium

Castles & Fortresses



- Coastal Fortress
- Wizard's Tower

Cities & Towns



- [Bramblewick](#)
- [Bramblewick Floorplans](#)
- [Mapleford Church](#)
- [Mapleford Market Square](#)
- [Mapleford Village and Candle & Kettle Inn \(Holiday Map Pack\)](#)
- [Mapleford Village and Candle & Kettle Inn \(Summer Map Pack\)](#)
- [Mapleford Village and Candle & Kettle Inn \(Winter Map Pack\)](#)

Coastal Adventures



- [Aspidochelone](#)
- [Coastal Fortress](#)
- [Deserted Island](#)
- [Drowned Sisters Grotto](#)
- [Grotto of the Goddess of Love](#)
- [Lighthouse Battlemap](#)

Dungeons & Caverns



- [Forest Temple Ruins](#)
- [Frostmaidens' Cradle](#)
- [Icy Ruins](#)
- [Rise of the Crone-Mother Campaign](#)
- [Withering Glade](#)
- [Womb of Ashes](#)

Floorplans



- Bramblewick Floorplans
- Mapleford Church
- The Old San Francisco Mint

Ruins & Landmarks



- Druid Henge
- Forest Temple Ruins
- Icy Ruins
- Lighthouse Battlemap

Temples & Churches



- Druid Henge
- Greco-Roman Temple & Crypts
- Grotto of the Goddess of Love
- Mapleford Church
- Royal Chapel

Wilderness Encounters

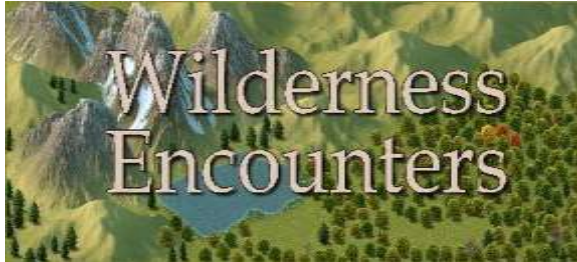

- [Deserted Island](#)
- [Winter Wilderness Map Pack](#)

Winter Adventures



- [Frostmaidens' Cradle](#)
- [Icy Ruins](#)
- [Mapleford Village and Candle & Kettle Inn \(Holiday Map Pack\)](#)
- [Mapleford Village and Candle & Kettle Inn \(Winter Map Pack\)](#)
- [Winter Wilderness Map Pack](#)

Series & Settings



Royal
Scribe
Imaginarium

Mapleford



Mapleford is a peaceful riverside village designed as a welcoming home base for fantasy adventures. Through changing seasons and an expanding collection of locations, the setting offers familiar landmarks, friendly faces, and richly detailed maps where journeys begin, mysteries unfold, and heroes return time and again.

- [Mapleford Church](#)
- [Mapleford Market Square](#)
- [Mapleford Village \[BUNDLE\]](#)
- [Mapleford Village and Candle & Kettle Inn \(Holiday Map Pack\)](#)
- [Mapleford Village and Candle & Kettle Inn \(Summer Map Pack\)](#)
- [Mapleford Village and Candle & Kettle Inn \(Winter Map Pack\)](#)

Season of the Hag



Season of the Hag is an interconnected fantasy series chronicling the rise of the Crone-Mother and her hag covens. Spanning haunted forests, drowned grottoes, fetid marshes, frozen peaks, and volcanic depths, each installment reveals another chapter in a larger tale of ancient evil, dark ritual, and creeping corruption.

- [Drowned Sisters' Grotto](#) (Sea Hag Lair Map Pack)
- [Frostmaidens' Cradle](#) (Alpine Hag Lair Map Pack)
- [Miremothers' Den](#) (Swamp Hag Lair Map Pack)
- [Rise of the Crone-Mother Campaign](#)
- [Rise of the Crone-Mother: The Complete Hag Lairs Bundle](#)
[BUNDLE]
- [Withering Glade](#) (Forest Hag Lair Map Pack)
- [Womb of Ashes](#) (Volcanic Hag Lair)

Wonderwood



Wonderwood is a vibrant fantasy setting where towering forests, hidden villages, and ancient magic invite exploration. Distinguished by its bright, storybook-inspired style and richly detailed environments, Wonderwood is home to Bramblewick and other locations designed for whimsical adventures, fey encounters, and memorable journeys.

- [Bramblewick](#)
- [Bramblewick Floorplans](#)
- [Wizard's Tower](#)

Royal Scribe Imaginarium



Crafting worlds of wonder...one map at a time.

Publisher & Copyright Holder: Kevin Goebel
publishing as Royal Scribe Imaginarium

Storefront: DriveThruRPG.com



Copyright

© 2025–2026 Kevin Goebel. All rights reserved.

Maps created using Campaign Cartographer 3+ under applicable ProFantasy licensing.

Usage License

This work is licensed for personal use only. You may print, share with your players, or use in streamed games. You may not resell, redistribute, or claim authorship of these materials or the artwork.

Permission is granted to feature these maps in live-streamed or recorded actual-play sessions, provided credit is given to "Kevin Goebel, Royal Scribe Imaginarium." Any commercial use of this product in streamed or recorded media, or incorporation into published works, requires prior written permission from Royal Scribe Imaginarium. For inquiries, please contact RoyalScribeSF@gmail.com.